

NICHIA CORPORATION

SPECIFICATIONS FOR UV LED

NVSU333A(T)

- Pb-free Reflow Soldering Application
- Built-in ESD Protection Device
- RoHS Compliant



SPECIFICATIONS

(1) Absolute Maximum Ratings

Item	Symbol	Absolute Maximum Rating	Unit
Forward Current	I_F	4500	mA
Pulse Forward Current	I_{FP}	6000	mA
Allowable Reverse Current	I_R	85	mA
Power Dissipation	P_D	18.9	W
Operating Temperature	T_{opr}	-10~85	°C
Storage Temperature	T_{stg}	-40~100	°C
Junction Temperature	T_J	100	°C

* Absolute Maximum Ratings at $T_S=25^\circ\text{C}$.

* I_{FP} conditions with pulse width $\leq 10\text{ms}$ and duty cycle $\leq 10\%$.

(2) Initial Electrical/Optical Characteristics

Item		Symbol	Condition	Typ	Max	Unit
U365	Forward Voltage	V_F	$I_F=3500\text{mA}$	3.85	-	V
	Radiant Flux	Φ_e	$I_F=3500\text{mA}$	3640	-	mW
	Peak Wavelength	λ_p	$I_F=3500\text{mA}$	365	-	nm
	Spectrum Half Width	$\Delta \lambda$	$I_F=3500\text{mA}$	9.0	-	nm
U385	Forward Voltage	V_F	$I_F=3500\text{mA}$	3.75	-	V
	Radiant Flux	Φ_e	$I_F=3500\text{mA}$	4640	-	mW
	Peak Wavelength	λ_p	$I_F=3500\text{mA}$	385	-	nm
	Spectrum Half Width	$\Delta \lambda$	$I_F=3500\text{mA}$	11.0	-	nm
U405	Forward Voltage	V_F	$I_F=3500\text{mA}$	3.55	-	V
	Radiant Flux	Φ_e	$I_F=3500\text{mA}$	4640	-	mW
	Peak Wavelength	λ_p	$I_F=3500\text{mA}$	405	-	nm
	Spectrum Half Width	$\Delta \lambda$	$I_F=3500\text{mA}$	12.0	-	nm
Thermal Resistance		$R_{\theta JS}$	-	1.68	2.08	°C/W

* Characteristics at $T_S=25^\circ\text{C}$.

* Radiant Flux value as per CIE 127:2007 standard.

* $R_{\theta JS}$ is Thermal Resistance from junction to T_S measuring point.

* It is recommended to operate the LEDs at a current greater than 10% of the sorting current to stabilize the LED characteristics.

RANKS

Item	Rank	Min	Max	Unit
Forward Voltage	H1	4.0	4.2	V
	M	3.6	4.0	
	L	3.2	3.6	
	K2	3.0	3.2	
Radiant Flux	P17d22	5790	6310	mW
	P17d21	5310	5790	
	P16d22	4870	5310	
	P16d21	4470	4870	
	P15d22	4100	4470	
	P15d21	3760	4100	
	P14d22	3450	3760	
	P14d21	3160	3450	
Peak Wavelength	U405	400	410	nm
	U385	380	390	
	U365	360	370	

* Ranking at T_s=25°C.

* Forward Voltage Tolerance: ±0.05V

* Radiant Flux Tolerance: ±6%

* Peak Wavelength Tolerance: ±3nm

* LEDs from the above ranks will be shipped.

The rank combination ratio per shipment will be decided by Nichia.

Forward Voltage Ranks by Peak Wavelength

Ranking by Peak Wavelength \ Ranking by Forward Voltage		K2	L	M	H1
		U365,U385			
U405					

Radiant Flux Ranks by Peak Wavelength

Ranking by Peak Wavelength \ Ranking by Radiant Flux		P14d21	P14d22	P15d21	P15d22	P16d21	P16d22	P17d21	P17d22
		U365							
U385,U405									

OUTLINE DIMENSIONS

* 本製品はRoHS指令に適合しております。
This product complies with RoHS Directive.

NVSU333A
管理番号 No. STS-DA7-5905A

(単位 Unit: mm, 公差 Tolerance: ±0.2)

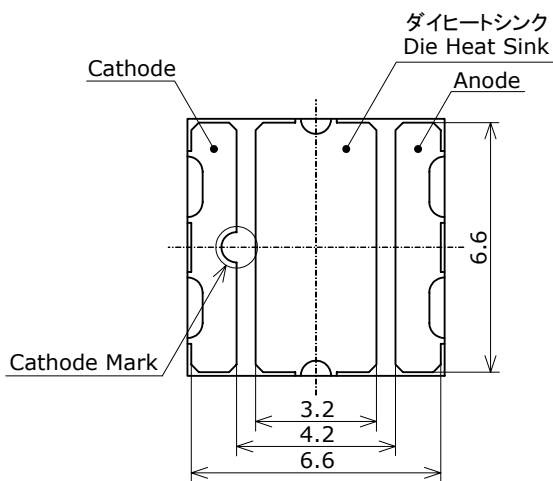
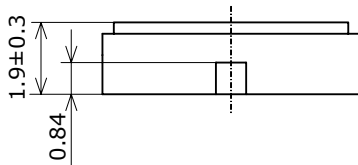
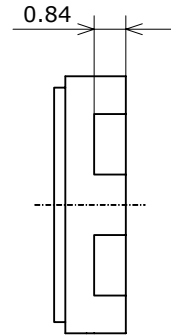
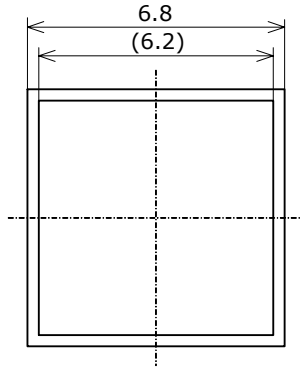

項目 Item	内容 Description
パッケージ材質 Package Materials	セラミックス Ceramics
ガラス窓材質 Glass Materials	硬質ガラス Hard Glass
接着剤材質 Adhesive Materials	シリコーン Silicone Adhesive
電極材質 Electrodes Materials	金メッキ Au-plated
ダイヒートシンク材質 Die Heat Sink Materials	金メッキ Au-plated
質量 Weight	0.26g(TYP)

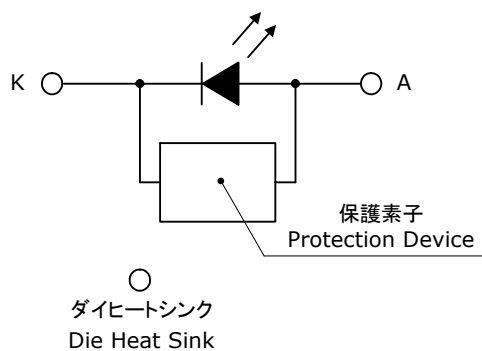

SOLDERING

• Recommended Reflow Soldering Condition(Lead-free Solder)

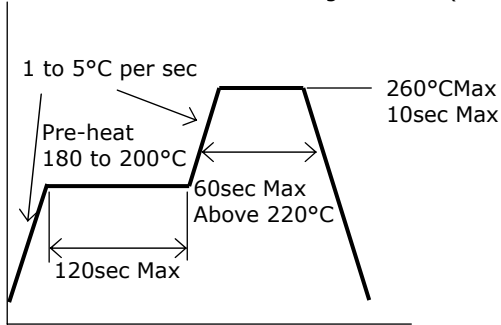

• Recommended Soldering Pad Pattern

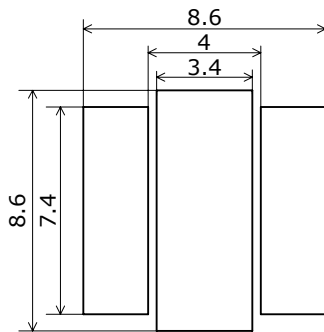

(単位 Unit: mm)

- * This LED is designed to be reflow soldered on to a PCB. If dip soldered or hand soldered, Nichia cannot guarantee its reliability.
- * Reflow soldering must not be performed more than twice.
- * Avoid rapid cooling. Ramp down the temperature gradually from the peak temperature.
- * Nitrogen reflow soldering is recommended. Air flow soldering conditions can cause optical degradation, caused by heat and/or atmosphere.
- * Repairing should not be done after the LEDs have been soldered.
It should be confirmed beforehand whether the characteristics of the LEDs will or will not be damaged by repairing.
- * The Die Heat Sink should be soldered to customer PCB.
If it is difficult or impossible, use high heat-dissipating adhesive.
- * When soldering, do not apply stress to the LED while the LED is hot.
- * When using a pick and place machine, choose an appropriate nozzle for this product.
- * The recommended soldering pad pattern is designed for attachment of the LED without problems.
When precise mounting accuracy is required, such as high-density mounting, ensure that the size and shape of the pad are suitable for the circuit design.
- * When flux is used, it should be a halogen free flux. Ensure that the manufacturing process is not designed in a manner where the flux will come in contact with the LEDs.
- * Make sure that there are no issues with the type and amount of solder that is being used.

PACKAGING - BULK

シリカゲルとともにICパックをアルミ防湿袋に入れ、熱シールにより封をします。
 Anti-static IC packs are shipped with desiccants in heat-sealed moisture-proof bags.

Nxxxxxxx
 管理番号 No. STS-DA7-1108B

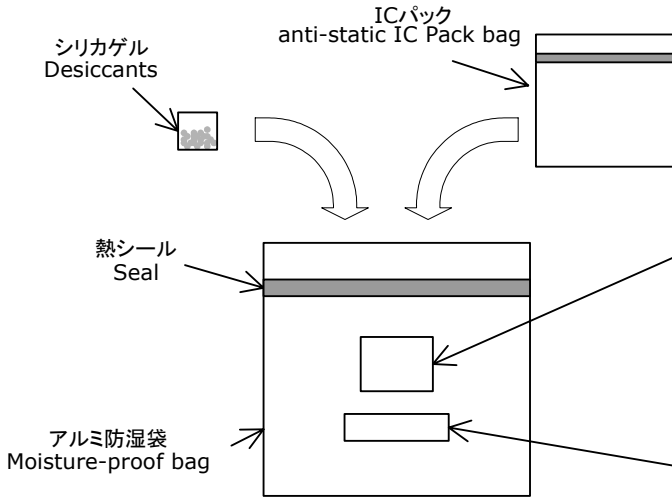

ラベル Label

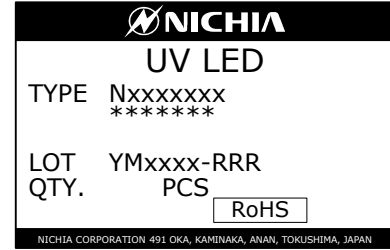

警告ラベル Warning and Explanatory Labels



アルミ防湿袋を並べて入れ、間隔にはクッション材を詰めます。
 Moisture-proof bags are packed in cardboard boxes with shock absorbing materials to fill empty spaces.

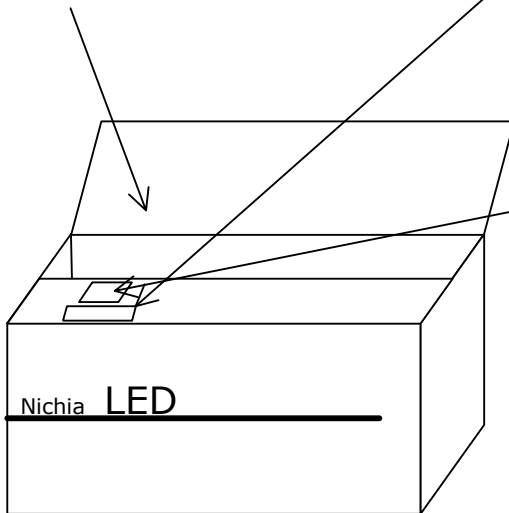

ラベル Label

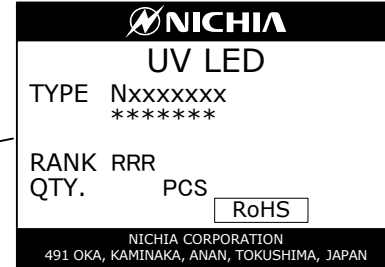

- * 客先型名を*****で示します。
 客先型名が設定されていない場合は空白です。
 ***** is the customer part number.
 If not provided, it will not be indicated on the label.
- * ロット表記方法についてはロット番号の項を参照して下さい。
 For details, see "LOT NUMBERING CODE" in this document.

- * 本製品はICパックに入れたのち、輸送の衝撃から保護するためダンボールで梱包します。
 Products shipped in anti-static IC packs are packed in a moisture-proof bag. They are shipped in cardboard boxes to protect them from external forces during transportation.
- * 取り扱いに際して、落下させたり、強い衝撃を与えたりしますと、製品を損傷させる原因になりますので注意して下さい。
 Do not drop or expose the box to external forces as it may damage the products.
- * ダンボールには防水加工がされておきませんので、梱包箱が水に濡れないよう注意して下さい。
 Do not expose to water. The box is not water-resistant.
- * 輸送、運搬に際して弊社よりの梱包状態あるいは同等の梱包を行って下さい。
 Using the original package material or equivalent in transit is recommended.

TAPE AND REEL DIMENSIONS

テーピング部 Tape

Nxxx333x
管理番号 No. STS-DA7-6280

(単位 Unit: mm)

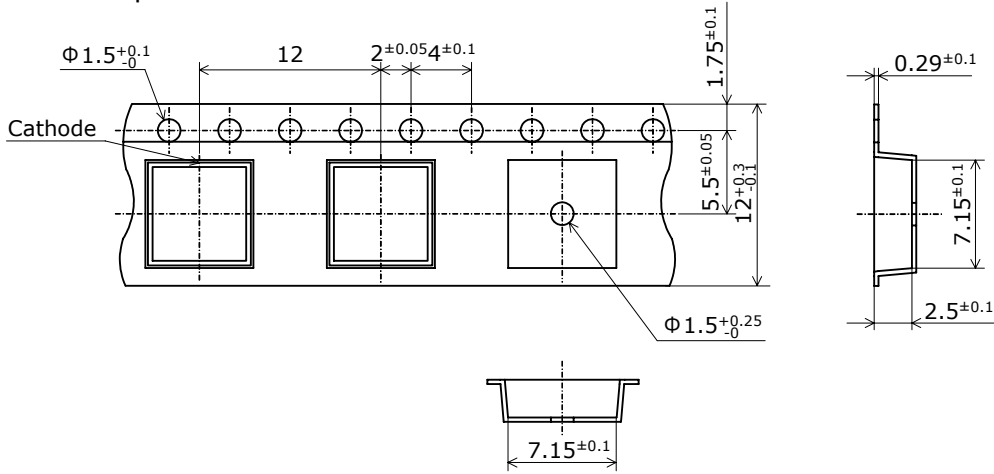

トレーラ部/リーダ部 Trailer and Leader

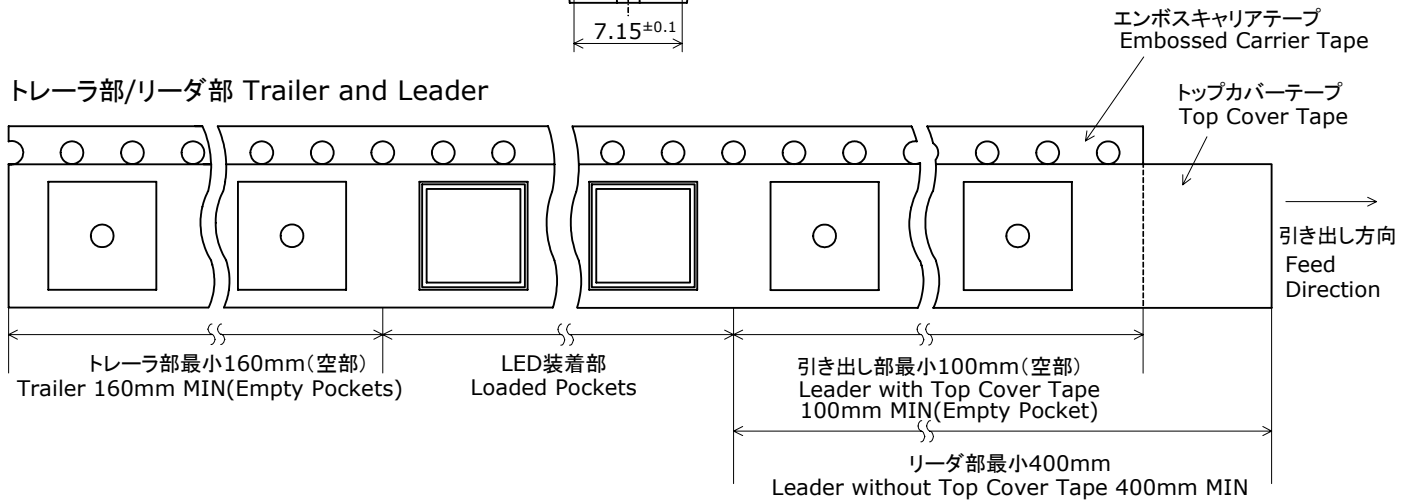

リール部 Reel

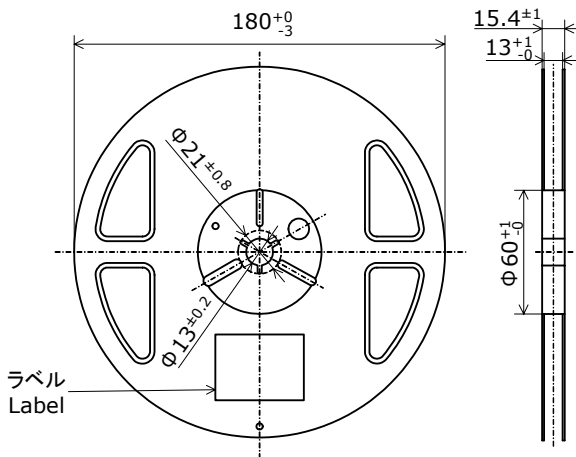

- * 数量は1リールにつき 500個入りです。
Reel Size: 500pcs
- * JIS C 0806電子部品テーピングに準拠しています。
The tape packing method complies with JIS C 0806 (Packaging of Electronic Components on Continuous Tapes).
- * 実装作業の中断などでエンボスキャリアテープをリールに巻き取る場合、エンボスキャリアテープを強く(10N以上)締めないで下さい。LEDがカバーテープに貼り付く可能性があります。
When the tape is rewound due to work interruptions, no more than 10N should be applied to the embossed carrier tape. The LEDs may stick to the top cover tape.

PACKAGING - TAPE & REEL

シリカゲルとともにリールをアルミ防湿袋に入れ、熱シールにより封をします。
Reels are shipped with desiccants in heat-sealed moisture-proof bags.

Nxxxxxxx
管理番号 No. STS-DA7-1109B

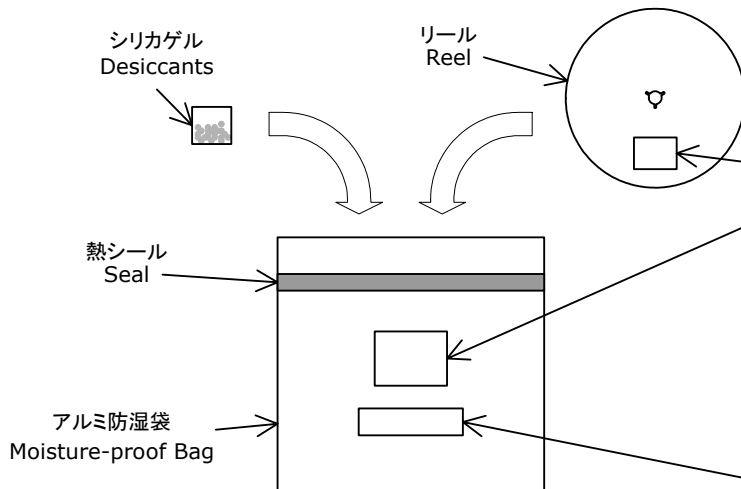

ラベル Label

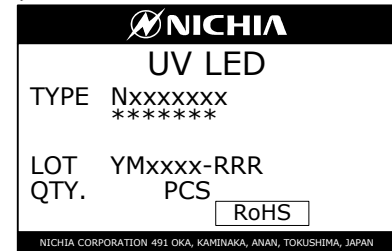

警告ラベル Warning and Explanatory Labels

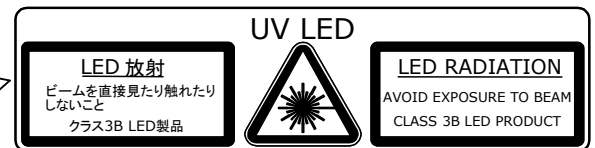

アルミ防湿袋を並べて入れ、ダンボールで仕切ります。
Moisture-proof bags are packed in cardboard boxes with corrugated partitions.

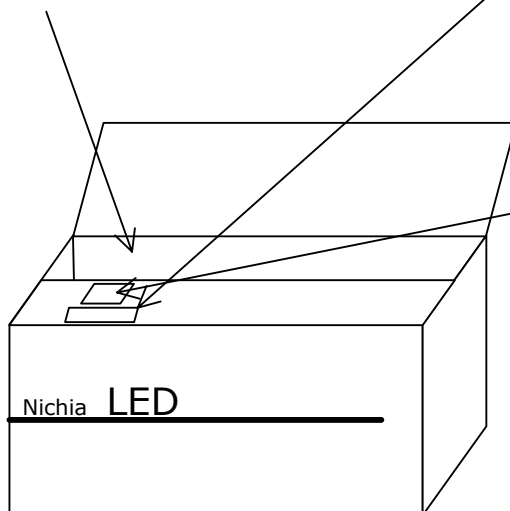

ラベル Label

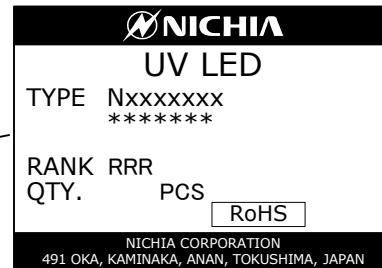

- * 客先型名を*****で示します。
客先型名が設定されていない場合は空白です。
***** is the customer part number.
If not provided, it will not be indicated on the label.
- * ロット表記方法についてはロット番号の項を参照して下さい。
For details, see "LOT NUMBERING CODE" in this document.

- * 本製品はテーピングしたのち、輸送の衝撃から保護するためダンボールで梱包します。
Products shipped on tape and reel are packed in a moisture-proof bag.
They are shipped in cardboard boxes to protect them from external forces during transportation.
- * 取り扱いに際して、落下させたり、強い衝撃を与えたりしますと、製品を損傷させる原因になりますので注意して下さい。
Do not drop or expose the box to external forces as it may damage the products.
- * ダンボールには防水加工がされておきませんので、梱包箱が水に濡れないよう注意して下さい。
Do not expose to water. The box is not water-resistant.
- * 輸送、運搬に際して弊社よりの梱包状態あるいは同等の梱包を行って下さい。
Using the original package material or equivalent in transit is recommended.

LOT NUMBERING CODE

Lot Number is presented by using the following alphanumeric code.

YMxxxx - RRR

Y - Year

Year	Y
2013	D
2014	E
2015	F
2016	G
2017	H
2018	I

M - Month

Month	M	Month	M
1	1	7	7
2	2	8	8
3	3	9	9
4	4	10	A
5	5	11	B
6	6	12	C

xxxx-Nichia's Product Number

RRR-Ranking by Wavelength, Ranking by Radiant Flux, Ranking by Forward Voltage

DERATING CHARACTERISTICS

NVSU333A
管理番号 No. STS-DA7-5906A

周囲温度-許容順電流特性
Ambient Temperature vs
Allowable Forward Current

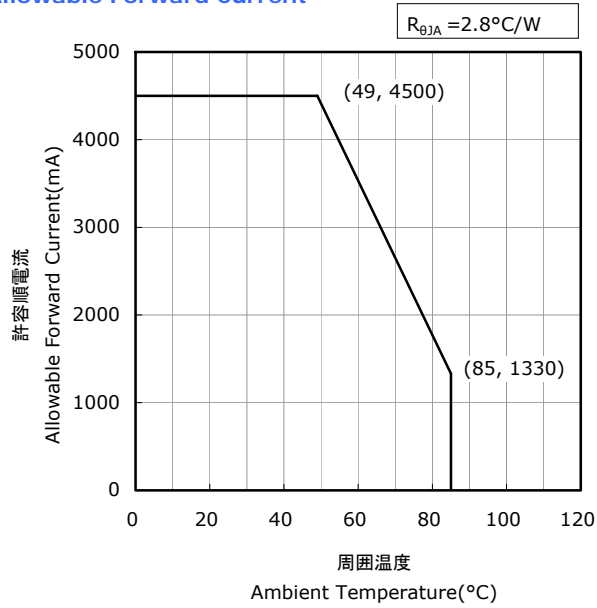

はんだ接合部温度(ダイヒートシンク部)-許容順電流特性
Solder Temperature(Die Heat Sink) vs
Allowable Forward Current

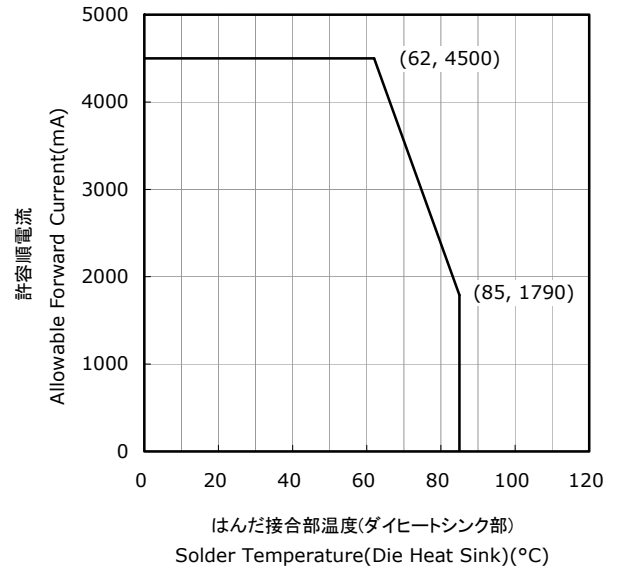

デューティー比-許容順電流特性
Duty Ratio vs
Allowable Forward Current

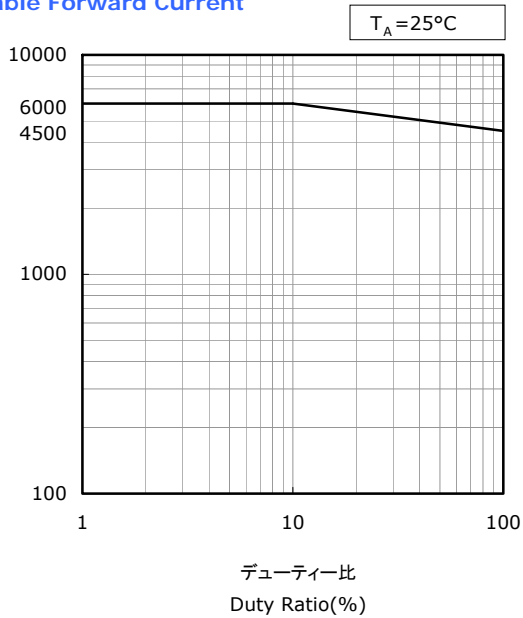

OPTICAL CHARACTERISTICS

* 本特性は参考です。
All characteristics shown are for reference only and are not guaranteed.

NVSU333A
管理番号 No. STS-DA7-6232

発光スペクトル
Spectrum

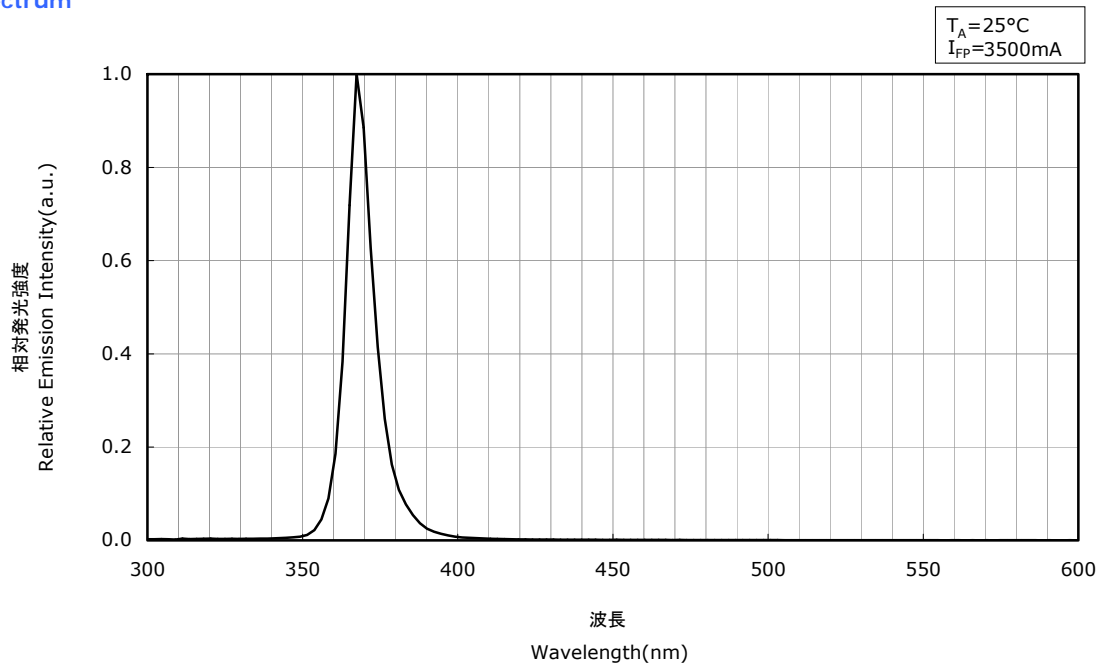

指向特性
Directivity

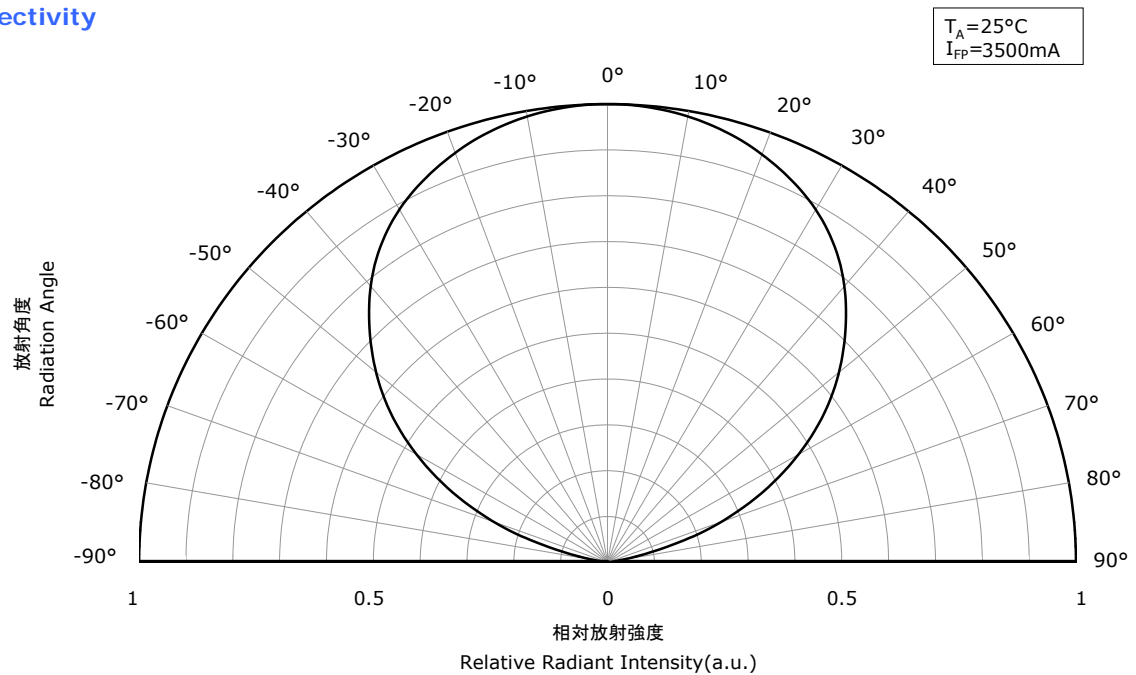

* 本特性はピーク波長ランクU365に対応しています。
The graphs above show the characteristics for U365 LEDs of this product.

OPTICAL CHARACTERISTICS

* 本特性は参考です。
All characteristics shown are for reference only and are not guaranteed.

NVSU333A
管理番号 No. STS-DA7-6233

発光スペクトル
Spectrum

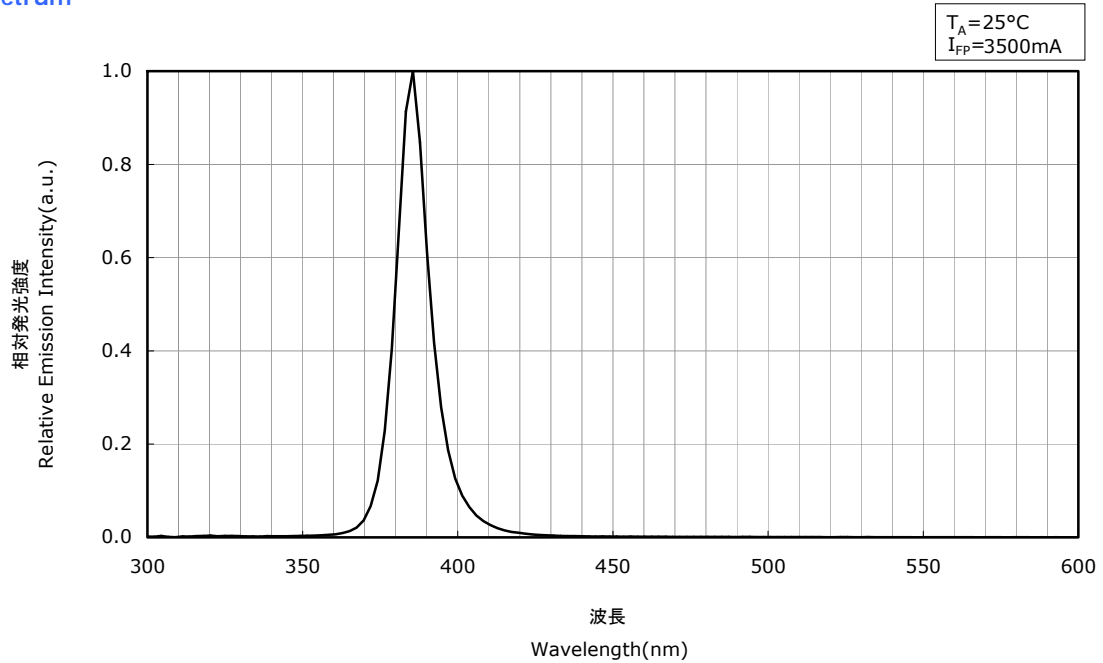

指向特性
Directivity

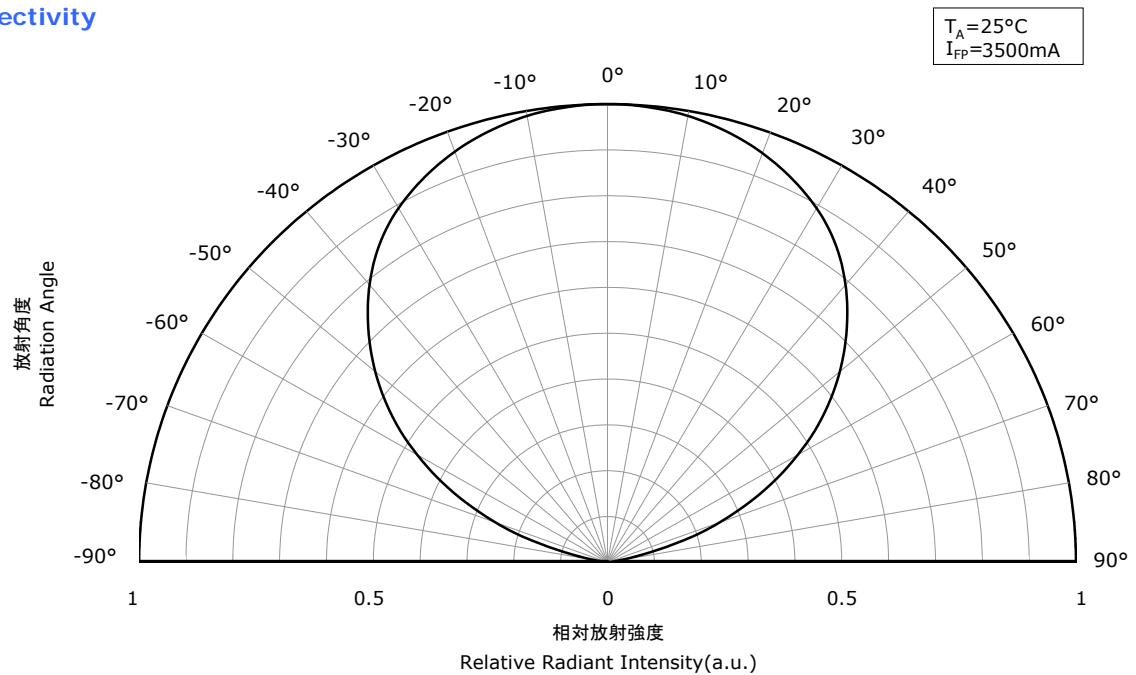

* 本特性はピーク波長ランクU385に対応しています。
The graphs above show the characteristics for U385 LEDs of this product.

OPTICAL CHARACTERISTICS

* 本特性は参考です。
All characteristics shown are for reference only and are not guaranteed.

NVSU333A
管理番号 No. STS-DA7-6234

発光スペクトル Spectrum

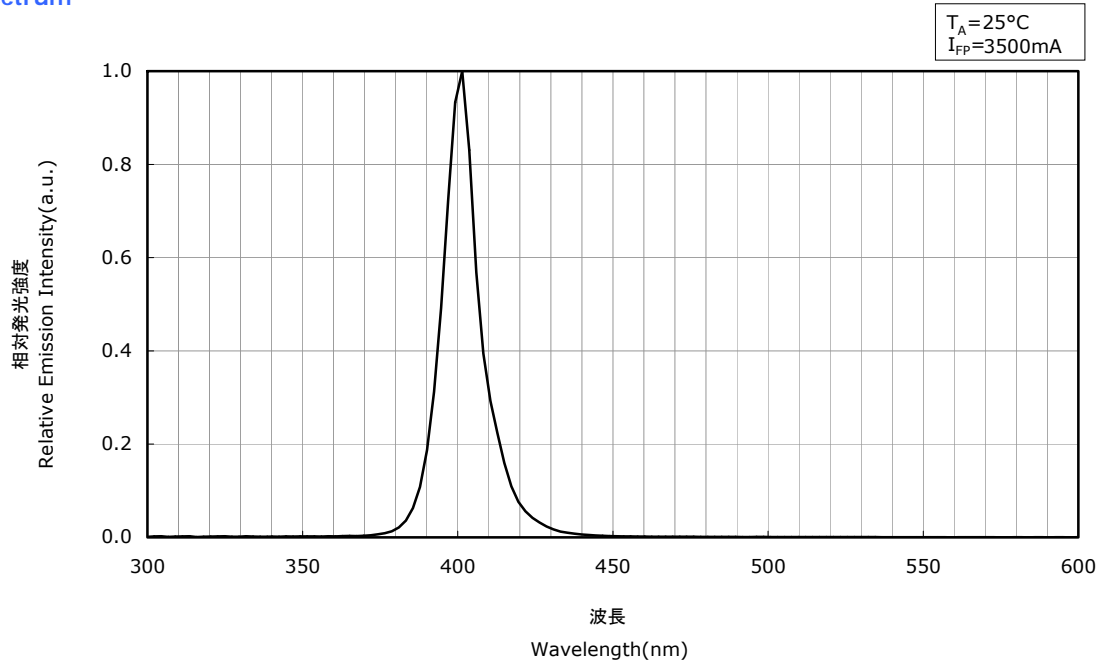

指向特性 Directivity

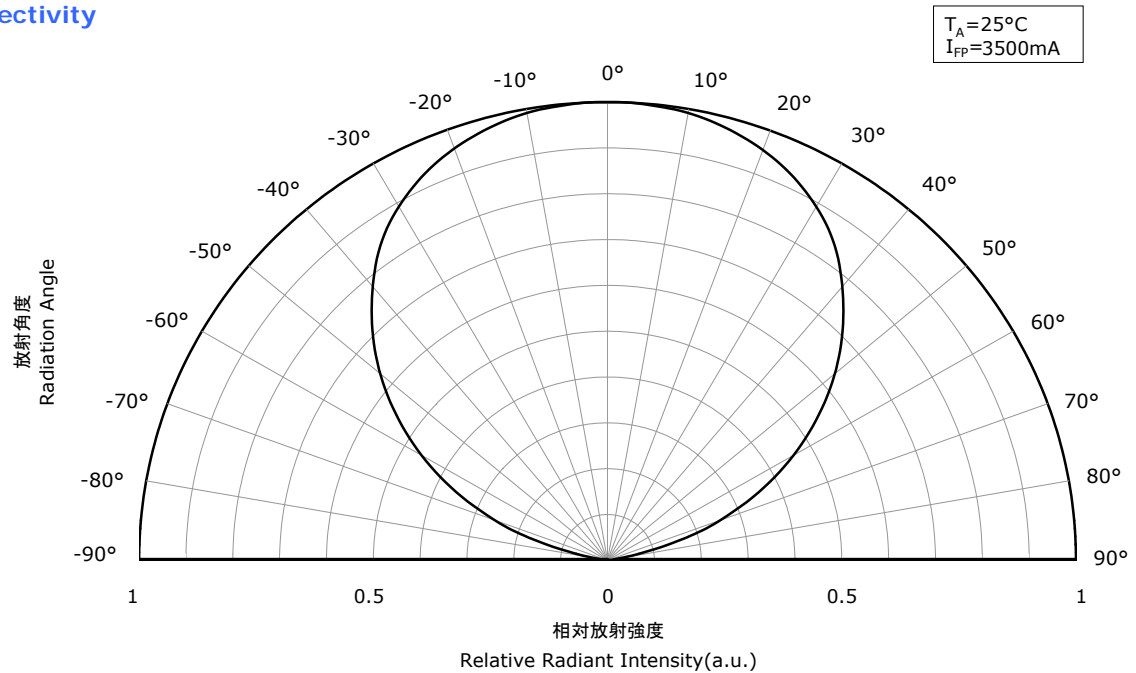

* 本特性はピーク波長ランクU405に対応しています。
The graphs above show the characteristics for U405 LEDs of this product.

FORWARD CURRENT CHARACTERISTICS / TEMPERATURE CHARACTERISTICS

* 本特性は参考です。
All characteristics shown are for reference only and are not guaranteed.

NVSU333A
管理番号 No. STS-DA7-6235

順電圧-順電流特性
Forward Voltage vs
Forward Current

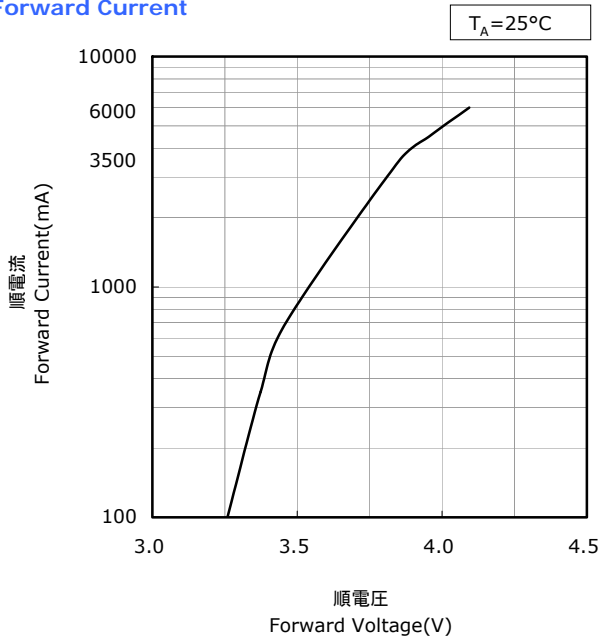

周囲温度-順電圧特性
Ambient Temperature vs
Forward Voltage

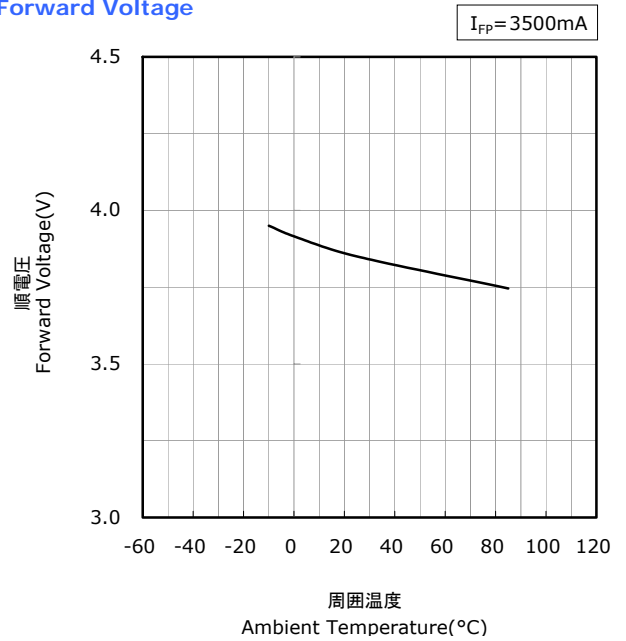

順電流-相対放射束特性
Forward Current vs
Relative Radiant Flux

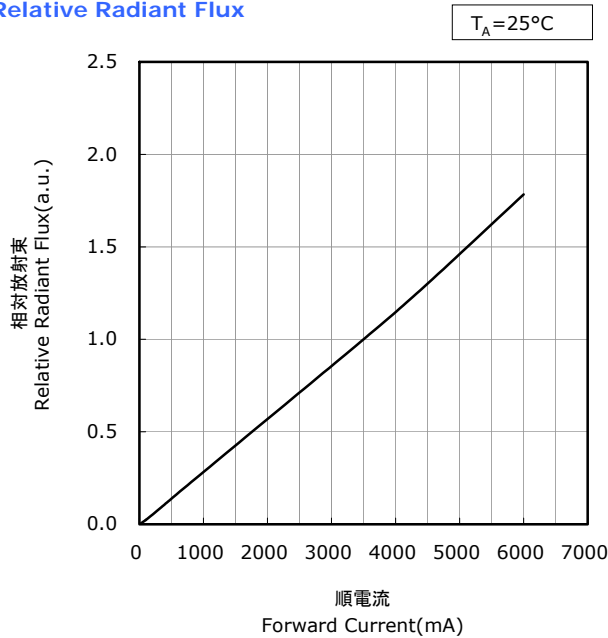

周囲温度-相対放射束特性
Ambient Temperature vs
Relative Radiant Flux

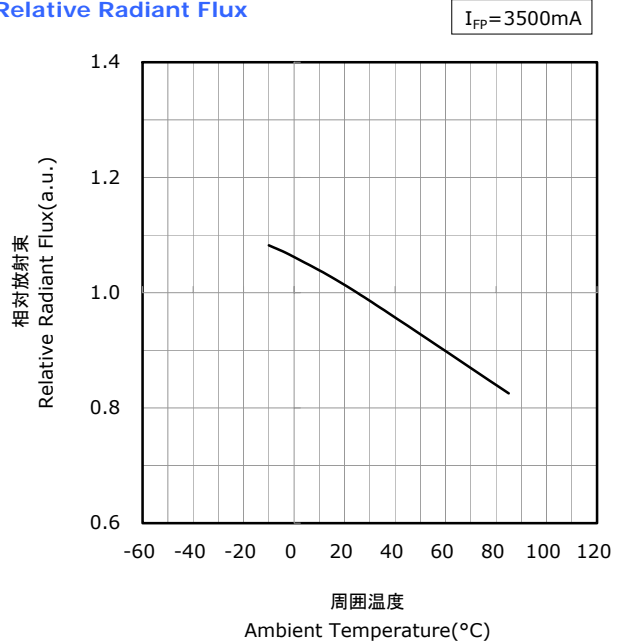

* 本特性はピーク波長ランクU365に対応しています。
The graphs above show the characteristics for U365 LEDs of this product.

FORWARD CURRENT CHARACTERISTICS / TEMPERATURE CHARACTERISTICS

* 本特性は参考です。
All characteristics shown are for reference only and are not guaranteed.

NVSU333A
管理番号 No. STS-DA7-6236

順電圧-順電流特性
Forward Voltage vs
Forward Current

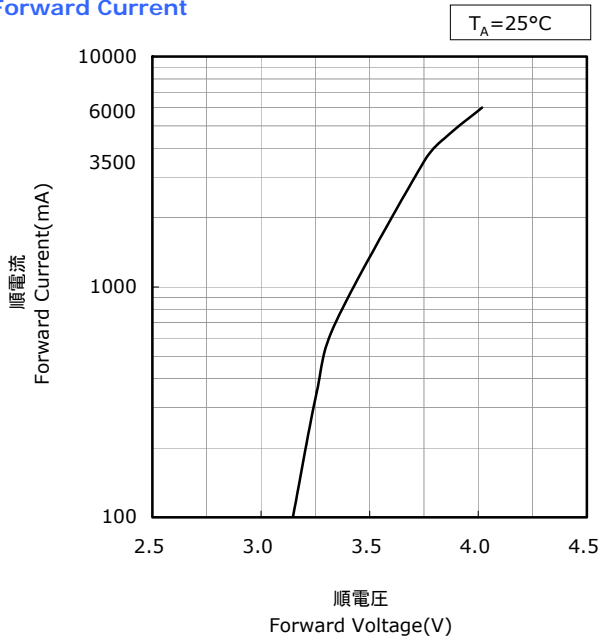

周囲温度-順電圧特性
Ambient Temperature vs
Forward Voltage

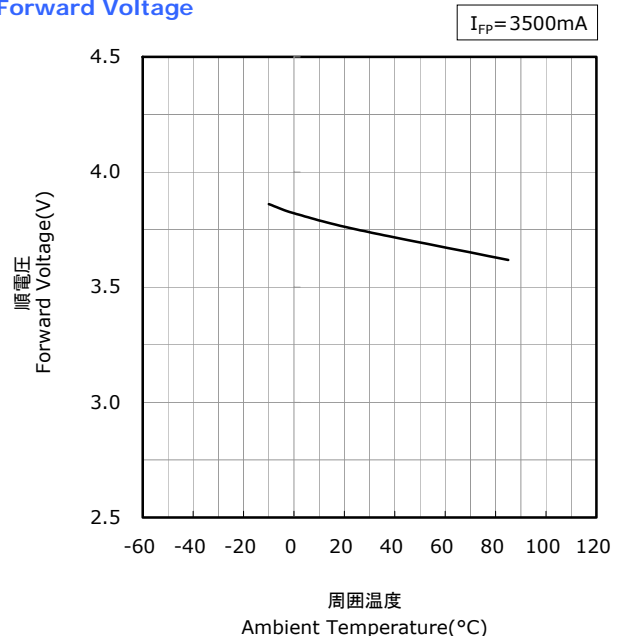

順電流-相対放射束特性
Forward Current vs
Relative Radiant Flux

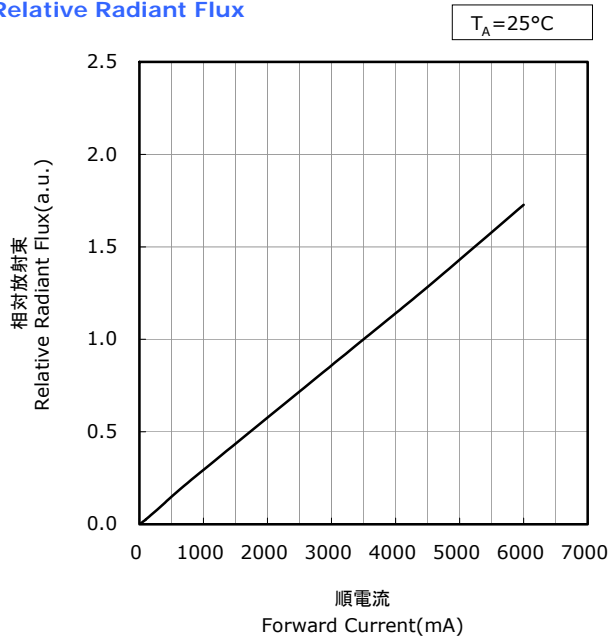

周囲温度-相対放射束特性
Ambient Temperature vs
Relative Radiant Flux

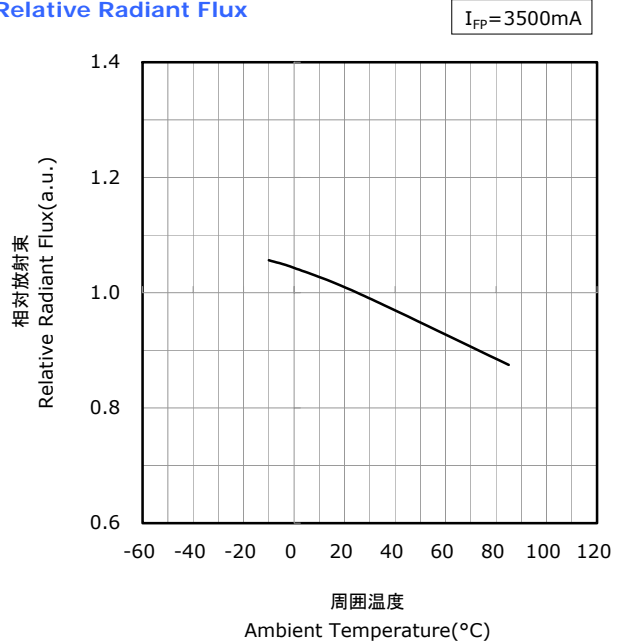

* 本特性はピーク波長ランクU385に対応しています。
The graphs above show the characteristics for U385 LEDs of this product.

FORWARD CURRENT CHARACTERISTICS / TEMPERATURE CHARACTERISTICS

* 本特性は参考です。
All characteristics shown are for reference only and are not guaranteed.

NVSU333A
管理番号 No. STS-DA7-6237

順電圧-順電流特性
Forward Voltage vs
Forward Current

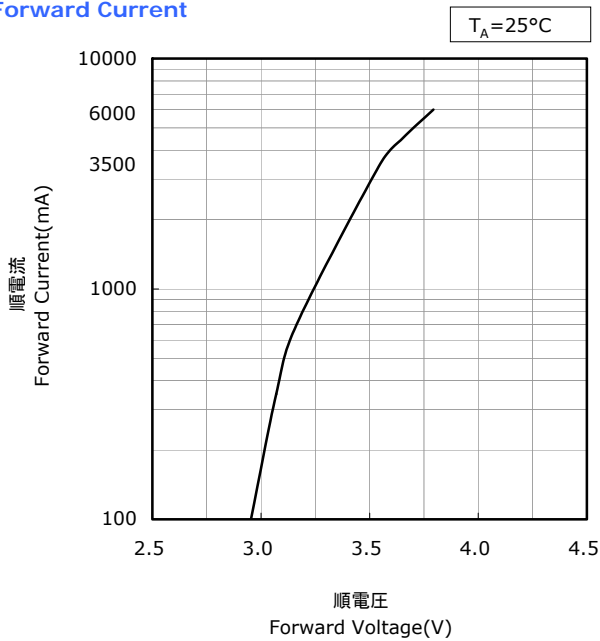

周囲温度-順電圧特性
Ambient Temperature vs
Forward Voltage

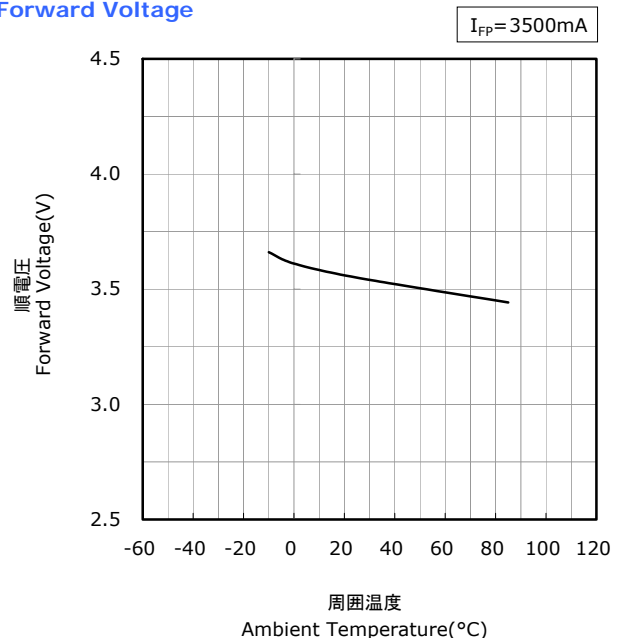

順電流-相対放射束特性
Forward Current vs
Relative Radiant Flux

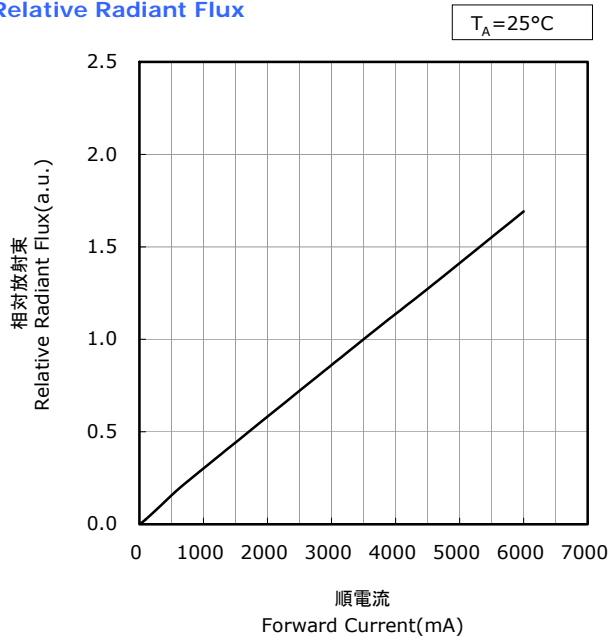

周囲温度-相対放射束特性
Ambient Temperature vs
Relative Radiant Flux

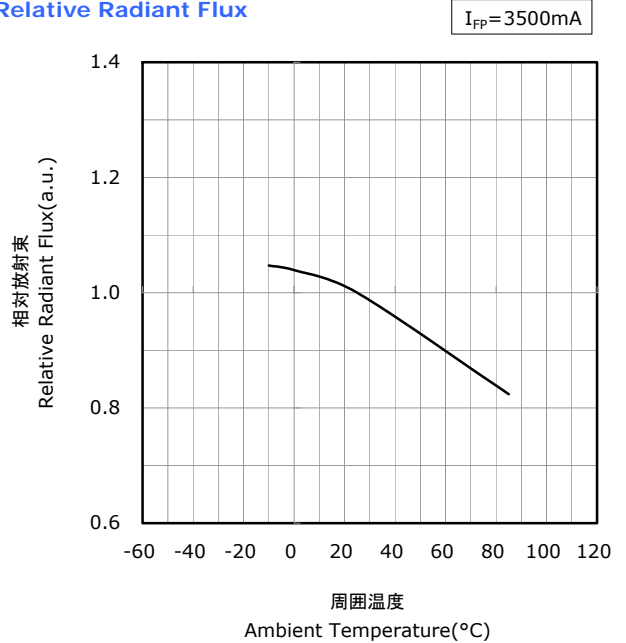

* 本特性はピーク波長ランクU405に対応しています。
The graphs above show the characteristics for U405 LEDs of this product.

FORWARD CURRENT CHARACTERISTICS / TEMPERATURE CHARACTERISTICS

* 本特性は参考です。
All characteristics shown are for reference only and are not guaranteed.

NVSU333A
管理番号 No. STS-DA7-6238

順電流-ピーク波長特性
Forward Current vs
Peak Wavelength

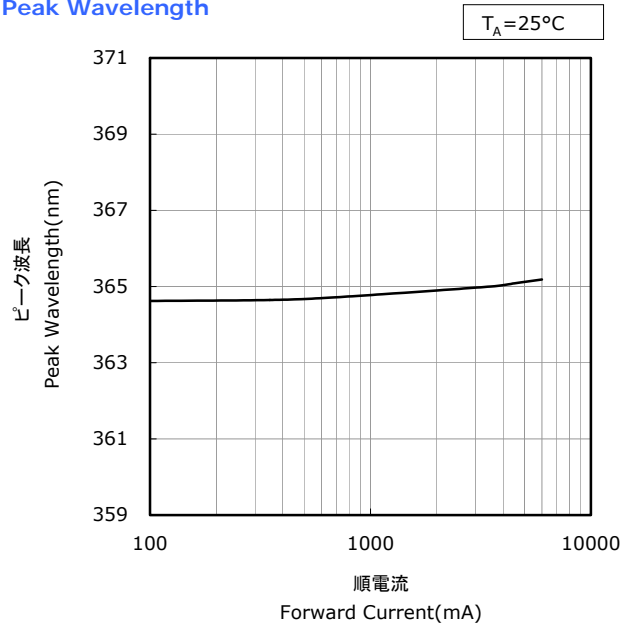

周囲温度-ピーク波長特性
Ambient Temperature vs
Peak Wavelength

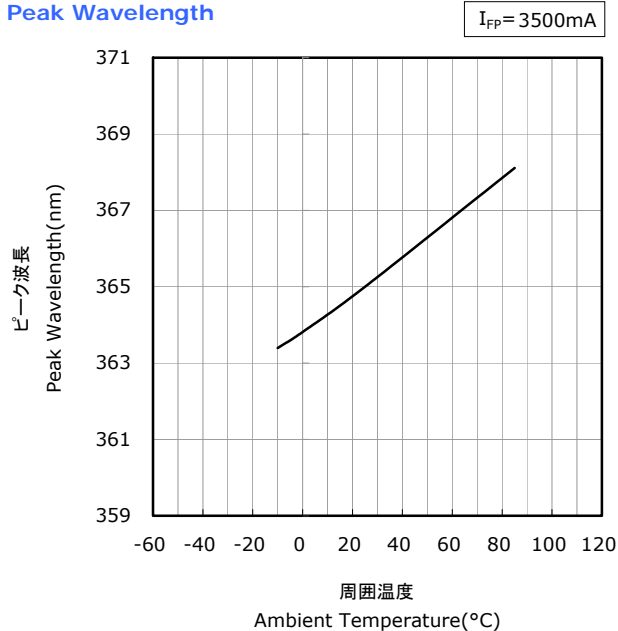

* 本特性はピーク波長ランクU365に対応しています。
The graphs above show the characteristics for U365 LEDs of this product.

FORWARD CURRENT CHARACTERISTICS / TEMPERATURE CHARACTERISTICS

* 本特性は参考です。
All characteristics shown are for reference only and are not guaranteed.

NVSU333A
管理番号 No. STS-DA7-6239

順電流-ピーク波長特性
Forward Current vs
Peak Wavelength

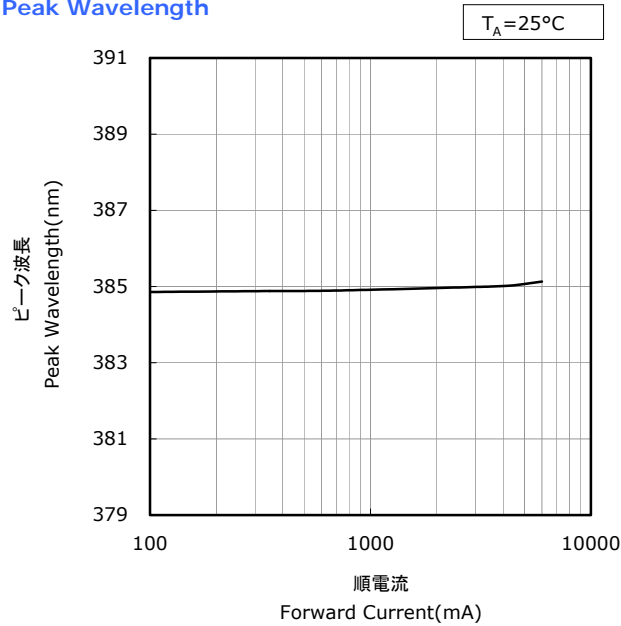

周囲温度-ピーク波長特性
Ambient Temperature vs
Peak Wavelength

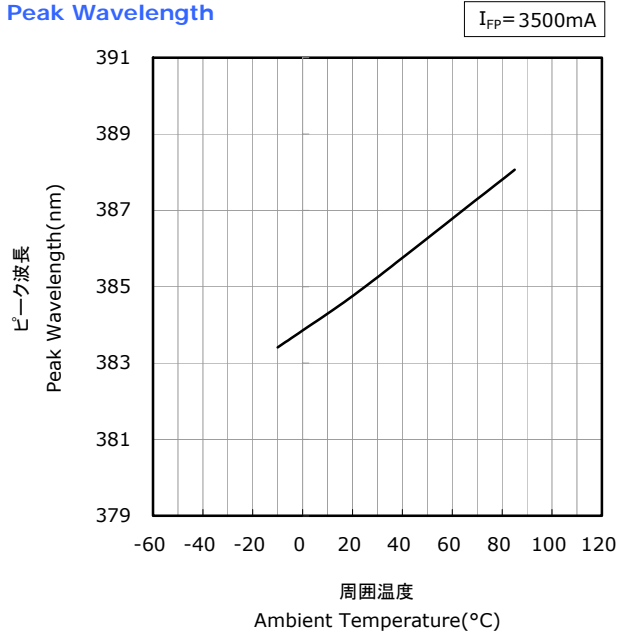

* 本特性はピーク波長ランクU385に対応しています。
The graphs above show the characteristics for U385 LEDs of this product.

FORWARD CURRENT CHARACTERISTICS / TEMPERATURE CHARACTERISTICS

* 本特性は参考です。
All characteristics shown are for reference only and are not guaranteed.

NVSU333A
管理番号 No. STS-DA7-6240

順電流-ピーク波長特性
Forward Current vs
Peak Wavelength

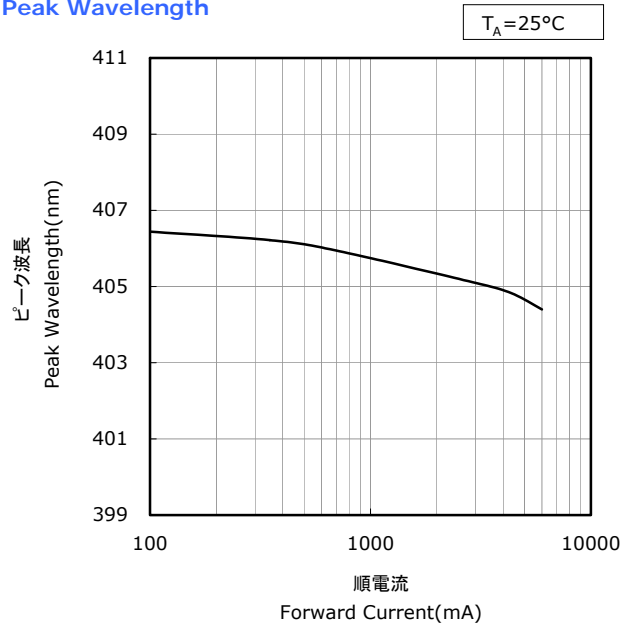

周囲温度-ピーク波長特性
Ambient Temperature vs
Peak Wavelength

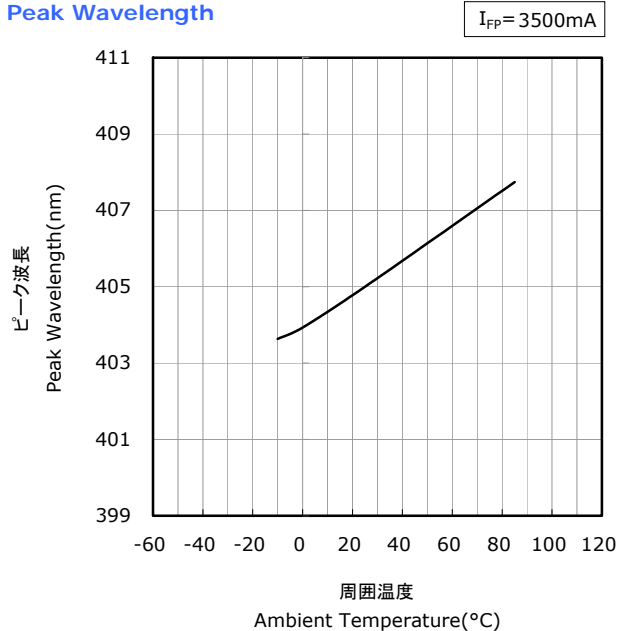

* 本特性はピーク波長ランクU405に対応しています。
The graphs above show the characteristics for U405 LEDs of this product.

RELIABILITY

(1) Tests and Results

Test	Reference Standard	Test Conditions	Test Duration	Failure Criteria #	Units Failed/Tested
Resistance to Soldering Heat (Reflow Soldering)	JEITA ED-4701 300 301	$T_{sld}=260^{\circ}\text{C}$, 10sec, 2reflows, Precondition: 30°C , 70%RH, 168hr		#1	0/10
Temperature Cycle	JEITA ED-4701 100 105	$-40^{\circ}\text{C}(30\text{min})\sim 25^{\circ}\text{C}(5\text{min})\sim 100^{\circ}\text{C}(30\text{min})\sim 25^{\circ}\text{C}(5\text{min})$	100cycles	#1	0/10
High Temperature Storage	JEITA ED-4701 200 201	$T_A=100^{\circ}\text{C}$	1000hours	#1	0/10
Low Temperature Storage	JEITA ED-4701 200 202	$T_A=-40^{\circ}\text{C}$	1000hours	#1	0/10
Room Temperature Operating Life		$T_A=25^{\circ}\text{C}$, $T_S=50^{\circ}\text{C}$, $I_F=4500\text{mA}$	1000hours	#1	0/10
Vibration	JEITA ED-4701 400 403	200m/s^2 , 100~2000~100Hz, 4cycles, 4min, each X, Y, Z	48minutes	#1	0/10
Electrostatic Discharges	JEITA ED-4701 300 304	HBM, 2kV, 1.5k Ω , 100pF, 3pulses, alternately positive or negative		#1	0/10

NOTES:

- 1) $R_{\theta JA} \approx 2.8^{\circ}\text{C/W}$
- 2) Measurements are performed after allowing the LEDs to return to room temperature.

(2) Failure Criteria

Criteria #	Items	Conditions	Failure Criteria
#1	Forward Voltage(V_F)	$I_F=3500\text{mA}$	>Initial value $\times 1.1$
	Radiant Flux(Φ_E)	$I_F=3500\text{mA}$	<Initial value $\times 0.7$

CAUTIONS

(1) Storage

Conditions		Temperature	Humidity	Time
Storage	Before Opening Aluminum Bag	$\leq 30^{\circ}\text{C}$	$\leq 90\% \text{RH}$	Within 1 Year from Delivery Date
	After Opening Aluminum Bag	$\leq 30^{\circ}\text{C}$	$\leq 70\% \text{RH}$	$\leq 168 \text{hours}$
Baking		$65 \pm 5^{\circ}\text{C}$	-	$\geq 24 \text{hours}$

- Product complies with JEDEC MSL 3 or equivalent. See IPC/JEDEC STD-020 for moisture-sensitivity details.
- Absorbed moisture in LED packages can vaporize and expand during soldering, which can cause interface delamination and result in optical performance degradation. Products are packed in moisture-proof aluminum bags to minimize moisture absorption during transportation and storage.
Included silica gel desiccants change from blue to red if moisture had penetrated bags.
- After opening the moisture-proof aluminum bag, the products should go through the soldering process within the range of the conditions stated above. Unused remaining LEDs should be stored with silica gel desiccants in a hermetically sealed container, preferably the original moisture-proof bags for storage.
- After the "Period After Opening" storage time has been exceeded or silica gel desiccants are no longer blue, the products should be baked. Baking should only be done once.
- Although the leads or electrode pads (anode and cathode) of the product are plated with gold, prolonged exposure to a corrosive environment might cause the gold plated the leads or electrode pads to tarnish, and thus leading to difficulties in soldering. If unused LEDs remain, they must be stored in a hermetically sealed container. Nichia recommends using the original moisture-proof bag for storage.
- Do not use sulfur-containing materials in commercial products. Some materials, such as seals and adhesives, may contain sulfur. The contaminated plating of LEDs might cause an open circuit. Silicone rubber is recommended as a material for seals. Bear in mind, the use of silicones may lead to silicone contamination of electrical contacts inside the products, caused by low molecular weight volatile siloxane.
- To prevent water condensation, please avoid large temperature and humidity fluctuations for the storage conditions.
- Do not store the LEDs in a dusty environment.
- Do not expose the LEDs to direct sunlight and/or an environment where the temperature is higher than normal room temperature.

(2) Directions for Use

- When designing a circuit, the current through each LED must not exceed the Absolute Maximum Rating. Operating at a constant current per LED is recommended. In case of operating at a constant voltage, Circuit B is recommended. If the LEDs are operated with constant voltage using Circuit A, the current through the LEDs may vary due to the variation in Forward Voltage characteristics of the LEDs.

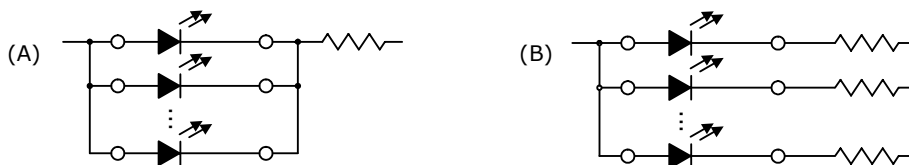

- This product should be operated using forward current. Ensure that the product is not subjected to either forward or reverse voltage while it is not in use. In particular, subjecting it to continuous reverse voltage may cause migration, which may cause damage to the LED die. When used in displays that are not used for a long time, the main power supply should be switched off for safety.
- It is recommended to operate the LEDs at a current greater than 10% of the sorting current to stabilize the LED characteristics.
- Ensure that excessive voltages such as lightning surges are not applied to the LEDs.
- For outdoor use, necessary measures should be taken to prevent water, moisture and salt air damage.
- This LED also emits visible light. Please take notice of visible light spectrum, in case you use this LED as light source of sensors etc.

(3) Handling Precautions

- Do not handle the LEDs with bare hands as it will contaminate the LED surface and may affect the optical characteristics: it might cause the LED to be deformed and/or the wire to break, which will cause the LED not to illuminate.
- When handling the product with tweezers, be careful not to apply excessive force to the resin.
Otherwise, The resin can be cut, chipped, delaminate or deformed, causing wire-bond breaks and catastrophic failures.
- Dropping the product may cause damage.
- Do not stack assembled PCBs together. Failure to comply can cause the resin portion of the product to be cut, chipped, delaminated and/or deformed. It may cause wire to break, leading to catastrophic failures.

(4) Design Consideration

- Although Nichia recommends using a copper PCB for this product, customer is advised to verify the PCB with the products before use. Stress during soldering can cause the glass lens to break and/or the solder joints to crack.
- PCB warpage after mounting the products onto a PCB can cause the package to break.
The LED should be placed in a way to minimize the stress on the LEDs due to PCB bow and twist.
- The position and orientation of the LEDs affect how much mechanical stress is exerted on the LEDs placed near the score lines.
The LED should be placed in a way to minimize the stress on the LEDs due to board flexing.
- Board separation must be performed using special jigs, not using hands.
- If an aluminum PCB is used, customer is advised to verify the PCB with the products before use.
Thermal stress during use can cause the solder joints to crack.

(5) Electrostatic Discharge (ESD)

- The products are sensitive to static electricity or surge voltage. ESD can damage a die and its reliability.
When handling the products, the following measures against electrostatic discharge are strongly recommended:
 - Eliminating the charge
 - Grounded wrist strap, ESD footwear, clothes, and floors
 - Grounded workstation equipment and tools
 - ESD table/shelf mat made of conductive materials
- Ensure that tools, jigs and machines that are being used are properly grounded and that proper grounding techniques are used in work areas. For devices/equipment that mount the LEDs, protection against surge voltages should also be used.
- If tools or equipment contain insulating materials such as glass or plastic, the following measures against electrostatic discharge are strongly recommended:
 - Dissipating static charge with conductive materials
 - Preventing charge generation with moisture
 - Neutralizing the charge with ionizers
- The customer is advised to check if the LEDs are damaged by ESD when performing the characteristics inspection of the LEDs in the application.
Damage can be detected with a forward voltage measurement at low current ($\leq 1\text{mA}$).
- ESD damaged LEDs may have current flow at a low voltage.
Failure Criteria: $V_F < 2.0\text{V}$ at $I_F = 0.5\text{mA}$

(6) Thermal Management

- Proper thermal management is an important when designing products with LEDs. LED die temperature is affected by PCB thermal resistance and LED spacing on the board. Please design products in a way that the LED die temperature does not exceed the maximum Junction Temperature (T_J).
- Drive current should be determined for the surrounding ambient temperature (T_A) to dissipate the heat from the product.
- The following equations can be used to calculate the junction temperature of the products.

$$1) T_J = T_A + R_{\theta JA} \cdot W \quad 2) T_J = T_S + R_{\theta JS} \cdot W$$

* T_J =LED junction temperature: °C

T_A =Ambient temperature: °C

T_S =Soldering temperature (die heat sink): °C

$R_{\theta JA}$ =Thermal resistance from junction to ambient: °C/W

$R_{\theta JS}$ =Thermal resistance from junction to T_S measuring point: °C/W

W =Input power($I_F \times V_F$): W

T_S Point

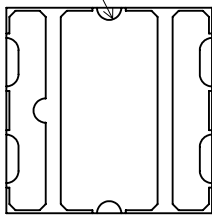

(7) Cleaning

- The LEDs should not be cleaned. Other cleaning agents except for Freon solvent should be tested prior to use whether they will not affect the package and the glass. Please note that Freon solvent is prohibited worldwide.
- Ultrasonic cleaning is not recommended since it may have adverse effects on the LEDs depending on the ultrasonic power and how LED is assembled.
If ultrasonic cleaning must be used, the customer is advised to make sure the LEDs will not be damaged prior to cleaning.

(8) Eye Safety

- In 2006, the International Electrical Commission (IEC) published IEC 62471:2006 Photobiological safety of lamps and lamp systems, which added LEDs in its scope.
On the other hand, the IEC 60825-1:2007 laser safety standard removed LEDs from its scope.
However, please be advised that some countries and regions have adopted standards based on the IEC laser safety standard IEC 60825-1:20112001, which still includes LEDs in its scope.
Most of Nichia's LEDs can be classified as belonging into either the Exempt Group or Risk Group 1.
High-power LEDs, that emit light containing blue wavelengths, may be classified as Risk Group 2.
Please proceed with caution when viewing directly any LEDs driven at high current, or viewing LEDs with optical instruments which may greatly increase the damages to your eyes.
- Viewing a flashing light may cause eye discomfort. When incorporating the LED into your product, please be careful to avoid adverse effects on the human body caused by light stimulation.
- The products are UV light LEDs, and radiate intense UV light during operation. Since UV light can be harmful to eyes, do NOT look directly into the UV light, even through an optical instrument. In case of the light reflection, UV protective glasses are required to use in order to avoid damage by the light.

(9) Others

- The LEDs described in this brochure are intended to be used for ordinary electronic equipment (such as office equipment, communications equipment, measurement instruments and household appliances).
Consult Nichia's sales staff in advance for information on the applications in which exceptional quality and reliability are required, particularly when the failure or malfunction of the LEDs may directly jeopardize life or health (such as for airplanes, aerospace, submersible repeaters, nuclear reactor control system, automobiles, traffic control equipment, life support systems and safety devices).
- The customer shall not reverse engineer by disassembling or analysis of the LEDs without having prior written consent from Nichia. When defective LEDs are found, the customer shall inform Nichia directly before disassembling or analysis.
- The specifications and appearance of this product may change without notice;
Nichia does not guarantee the contents of this specification. Both the customer and Nichia will agree on the official specifications of supplied products before the volume production of a program begins.